

# Handbook for Gas Chromatograph Accessories



# Shimadzu Gas Chromatograph

Gas chromatographs require different peripherals and supplies depending on the analytical purpose, especially as it relates to gas management, flow line configuration, column installation, sample injection and data processing. This brochure introduces various accessories and supplies supported by Shimadzu GC instruments.



Nexis GC-2030 + AOC-30i/20s U (Option)

## Gas Chromatograph Nexis GC-2030

Nexis GC-2030, Shimadzu's high-end gas chromatograph, is a new-generation gas chromatograph that combines improved operation and easier maintenance with the world's highest levels of performance for sensitivity and reproducibility. A color touch-panel interface with clear, intuitive graphics enables all users to monitor the instrument status and set parameters with ease. In addition, Nexis GC-2030 offers excellent usability with tool-free inlet maintenance and column installation and a built-in oven light. It also provides a variety of functions to ensure compliance with GLP/GMP and a self-diagnosis function.

(Detailed product brochure: C184-E043)

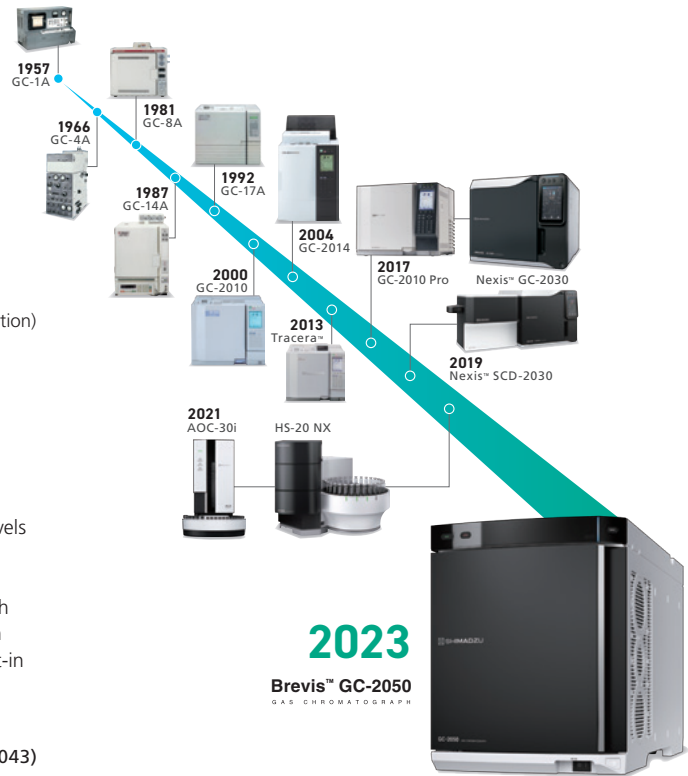

Brevis GC-2050+AOC-30i (Option)

## Gas Chromatograph GC-2050

"Smaller, simpler, and easier to use – without compromising performance." That's the demand from analysts. And that's why Shimadzu developed the Brevis GC-2050. This new space-saving GC delivers uncompromising analytical performance in a modern yet rugged design, easily meeting the analysis needs of laboratories in a range of industries.

(Detailed product brochure: C184-E050)



GC-2014 + AOC-20i (Option)

## Gas Chromatograph GC-2014 Series

The GC-2014 offers high expandability and flexibility with the ability to mount multiple injectors and detectors. Available for both packed and capillary columns, it offers an excellent user interface with a large LCD, digital gas control and auto-diagnostics, and innovative technology for all injectors, detectors and flow controllers.

(Detailed product brochure: C184-E014)

# Contents

	Description	P/N	Compatible Models					Remarks	Page	
			GC-2030	GC-2050	GC-2014	GC-2025	GC-2010 Plus			
Sampling Device	Autoinjector	AOC-30i	221-86000-58	✓	✓				Standalone	6
			221-86002-58	✓	✓				For sampler	
		AOC-20i Plus	221-86003-58	✓	✓	✓	✓	✓		
	Barcode/2D Code Reader for AOC		221-85900-58	✓	✓				For AOC-30i/AOC-20s U	
	Sample Cooling Fan		221-44995-91	✓	✓	✓	✓	✓		
	Long Turret		221-45622-91	✓	✓	✓	✓	✓		
	Large Vial Holder		221-32949-01	✓	✓	✓	✓	✓		
	4mL Vial Holder, Sampler		221-45182	✓	✓	✓	✓	✓		
	Autosampler	AOC-20s U	221-86001-58	✓	✓	✓	✓	✓		
	Vial Cooling/Heating Unit	For 1.5 mL vial	221-85189-43	✓	✓	✓	✓	✓		
		For 4.0 mL vial	221-85189-44	✓	✓	✓	✓	✓	For AOC-20s U	
	Gas Sampler	MG5-2030	221-78990-41	✓						
		MG5-2010	221-75363-41					✓		
		MG5-4	221-42574-02			✓			✓	
221-42868-91										
MG5-5		221-42576-41			✓			✓		
	221-42585-41									
Injection Splitter		221-78280-41	✓							
		221-76252-41					✓			
Headspace Sampler	HS-20 NX	225-41000-41/42/58	✓	✓				✓		
	HS-20 NX Trap	225-41001-41/42/58	✓					✓		
	HS-20 LT	225-22050-41/42/58	✓		✓			✓		
	HS-10	221-76862-11	✓		✓			✓		
Barcode Reader for HS-20		225-23340-41	✓	✓	✓			✓		
Needle		See text	✓	✓	✓			✓		
Sample Loop		See text	✓	✓	✓			✓		
Thermal Desorption System	TD-30	225-30600-58	✓					✓		
	TD-30R	225-30700-58	✓					✓		
Barcode Reader for TD-30		225-32325-41	✓					✓		
Sample Tube		See text	✓					✓		
Trap Tube		See text	✓					✓		
Sample Injection Unit	Split/Splitless Sample Injection Unit	SPL-2030	221-77100-41/44	✓						
		SPL-2030 deactivated	221-77100-62/65	✓						
		SPL-U	221-87500-58		✓					
		SPL-U deactivated	221-87500-61		✓					
		SPL-2010 Plus	221-73040-41/48						✓	
	SPL-2014	221-75046-41/44			✓					
	Wide-Bore Injection Unit	WBI-2030	221-78200-41/44	✓						
		WBI-2010 Plus	221-73041-41/48						✓	
		WBI-2014	221-75047-41/44			✓				
		WBI-2014 (AMC)	221-75038-41/44			✓				
	Single Packed Injection Unit	SINJ-2014	221-75037-41/44			✓				
		SINJ-2030	221-85187-41/48	✓						
	Wide-Bore Capillary Column Attachment		See text	✓		✓				
	On-column/ Programmed Temperature Vaporization Injection Unit	OCI-2030	221-78300-41/42/48	✓						
OCI-2030 NX		221-85800-41/42/48	✓					Not applicable for simple OCI insert		
PTV-2030		221-78350-41/42/48	✓							
OCI/PTV-2010		221-71042-41/44						✓		
Septum Nut		See text	✓	✓	✓	✓	✓			
Nut and Graphite Ferrule for Capillary Columns		See text	✓	✓	✓	✓	✓			
Nut and Vespel Ferrule for Capillary Columns		See text	✓	✓	✓	✓	✓			
Nut and ClickTek Ferrule for Capillary Columns		See text	✓	✓		✓	✓			
Prefix Tool		221-76547-43	✓	✓		✓	✓			
Column Connection Parts		See text	✓	✓	✓	✓	✓			
Packed Column Connections		See text	✓		✓			✓		
Septum for Injection Port		See text	✓	✓	✓	✓	✓			

	Description	P/N	Compatible Models					Remarks	Page
			GC-2030	GC-2050	GC-2014	GC-2025	GC-2010 Plus		
Column Oven	Cryogenic Valve Unit	CRG-2030 CO <sub>2</sub>	221-78900-41	✓	✓				
		CRG-2030 LN <sub>2</sub>	221-80819-41	✓	✓				
		CRG-2010 CO <sub>2</sub>	221-48703-91/42/48			✓		✓	
		CRG-2025 CO <sub>2</sub>	221-73920-41/42/44				✓		CO <sub>2</sub> only
		CRG-2010 LN <sub>2</sub>	221-49588-91/42/48			✓		✓	
	Oven Light Unit		221-78939-41	✓					
	Oven Insert		221-85807-41	✓					
	Column Hanger		221-47159	✓		✓	✓	✓	For one column
			221-87290		✓				
			221-72849	✓			✓	✓	For two columns
			221-70200			✓			For one column, vertical orientation
	Exhaust Duct		221-80955-41	✓					
			221-85232-41	✓					
			221-87248		✓				Can be connected directly to spiral duct.
			221-70675-41			✓			
		221-73965-41				✓			
		221-47748-41				✓			
Detector	Flame Ionization Detector	FID-2030	221-77200-41/44	✓					Capillary/packed
		FID-U	221-87503-58		✓				
		FID-2010 Plus	221-73345-41/42/48					✓	Capillary/packed
		FID-2014 Single	221-75030-41/42/44/46			✓			
	FID Nozzle		See text	✓	✓	✓	✓	✓	
	FID Collector		See text	✓	✓	✓	✓	✓	
	FID Custom Kit for Wide Concentration Range		221-88280-41	✓					
			221-88280-46		✓				
	FID Custom Kit for Packed Columns		221-85191-41	✓					
	Capillary Adapter for DFID		221-33193-91			✓			
Thermal Conductivity Detector	TCD	-	Order it factory-installed in the GC main unit.					Capillary/packed	
Capillary Adapter for TCD		221-34012-91			✓				
		221-82865-42	✓					For PTC-2030	
Barrier Discharge Ionization Detector	BID-2030	221-77700-41/44	✓						
	BID-2010 Plus	221-76000-41/42/44					✓	Capillary	
Helium Purifier	HP-2	221-75538-41/42	✓				✓		
Jetanizer		220-94673-30	✓	✓					
ECD Controller		221-77540-41/42	✓						
		221-87610-41		✓				For ECD-2010 Exceed	
		221-77550-41/42					✓		
		221-47733-41/42					✓	For ECD-2010 Plus	
		221-75032-41/42/44			✓			For ECD-2014	
ECD Cell		See text	✓	✓	✓		✓		
ECD Flow Bypass Kit		221-49664-42					✓	For ECD-2010 Exceed (does not need to be ordered for GC-2030)	
		221-49664-41					✓	For ECD-2010 Plus	
Sulfur Chemiluminescence Detector	SCD-2030	221-84085-41/58	✓					Capillary for installation on left side	
		221-84185-41/58	✓					Capillary for installation on right side	
Flame Photometric Detector	FPD-2030	221-77600-41/48	✓					Capillary	
	FPD-U	221-87506-58		✓					
	FPD-2010 Plus	221-73334-41/42/48					✓	Capillary/packed	
	FPD-2014	221-75031-41/42/44			✓				
Interference Filter		See text	✓	✓	✓		✓		
Photomultiplier Purge Kit	FPD-2030	221-81010-41	✓	✓				Capillary	
	FPD-2010 Plus	221-72652-43					✓	Capillary/packed	
	FPD-2014	221-72652-44			✓			Packed	
Flame Thermionic Detector	FTD-2030	221-77800-41/48	✓					Capillary	
	FTD-2010 Plus	221-73332-41/42/48					✓		
	FTD-2014	221-75033-41/42/44			✓			Packed	
	FTD-2014C	221-75034-41/42/44			✓			Capillary	
FTD Collector Regeneration Kit		221-49079-91	✓		✓		✓		

	Description		P/N	Compatible Models					Remarks	Page	
				GC-2030	GC-2050	GC-2014	GC-2025	GC-2010 Plus			
Accessories for Safety and Environmental Friendliness	Hydrogen Option Kit, AFC		221-83785-41	✓		✓	✓	✓		20	
			221-87283-41		✓						
	Hydrogen Option Kit, APC		221-83780-41	✓		✓	✓	✓	Flow channel resistance limits the APC hydrogen flowrate.		
			221-87280-41		✓						
	Supply Gas Shut-off Solenoid Valve Unit		221-70782-41			✓					
	Securement Parts		GC	221-78975	✓						Hardware for fastening the GC unit to the instrument stand.
				221-87606-41		✓					
				221-61192			✓				For fastening right side
				221-61193			✓				For fastening left side
			221-73967-41				✓				
SCD			221-84168	✓							
AOC-30i			221-86017-41	✓	✓						
AOC-20i		221-74090-43	✓	✓		✓	✓				
		221-74090-42			✓						
HS-20		225-23414-41	—	—	—	—	—				
Vent Tube		221-77174-41	✓	✓	✓	✓	✓	5 m			
Gas Utility	Air Generator	AGE-1000	221-74500-01	✓	✓	✓	✓	✓	Only compatible with FIDs	21	
	Air Compressor		Oil-less Type	221-72380	✓	✓	✓	✓	✓		55/57 dB (A) at 50/60 Hz
			Oil-less, Quiet Type	042-70041-02	✓	✓	✓	✓	✓		47 dB
Hydrogen Gas Generator	Precision Series	Refer to brochure		✓	✓	✓	✓	✓			
Gas Filter	Super-Clean Gas Filter		See text	✓	✓	✓	✓	✓		22	
	Filter Regulator		221-56748-01	✓	✓	✓	✓	✓			
	Moisture Trap (Silica gel)		201-36688	✓	✓	✓	✓	✓			
	Filter Joint		201-43969	✓	✓	✓	✓	✓			
	Oxygen Trap		221-46985-91	✓	✓	✓	✓	✓			
	Syringe for Cleaning		221-35641-91	✓	✓	✓	✓	✓			
	Filter for Flow Controller		221-77580-42	✓	✓						
221-42559-92			✓	✓	✓	✓	✓				
221-34121-94			✓	✓	✓	✓	✓	Additional filter for moisture			
Operating Parts	Gas Selector		221-84916-41	✓	✓					24	
	Shimadzu M/G Type Joint		See text	✓	✓	✓	✓	✓			
	Pressure Regulator for High-Purity Gas		PPR-N <sub>2</sub>	221-35999-01	✓	✓	✓	✓	✓		
			PPR-H <sub>2</sub>	221-35999-02	✓	✓	✓	✓	✓		
			PPR-He	221-35999-03	✓	✓	✓	✓	✓		
	Gas Supply Tube		See text	✓	✓	✓	✓	✓			
	Swagelok Adapter		221-25975-92	✓	✓	✓	✓	✓			
	Needle Valve		221-57298	✓	✓	✓	✓	✓			
	Running Tool Kit, for GC		Basic set	221-38650-90	✓	✓	✓	✓	✓		
			Basic set, PPR-N <sub>2</sub>	221-38650-91	✓	✓	✓	✓	✓		
Basic set, PPR-He			221-38650-92	✓	✓	✓	✓	✓			
FID Operation Parts Set		without Regulator	221-38651-90	✓	✓	✓	✓	✓			
		with Regulator		221-38651-91	✓	✓	✓	✓	✓	Hydrogen gas tubing (right-hand threads)	
				221-38651-92	✓	✓	✓	✓	✓	Hydrogen gas tubing (left-hand threads)	
Data Processor	Chromatography Data Acquisition Module CBM-201m		221-80265-58	—	—	—	—	—		27	
	PC Peripherals		See text	—	—	—	—	—			

# Sampling Device

## Autoinjector/Autosampler AOC Series

The AOC-30i is a next-generation intelligent autoinjector with Sampler Navigator functionality that is packed with injection expertise. The skip function uses vial-sensing technology to increase throughput and help improve data integrity. The 30-vial sample capacity is large enough to handle most workflows, but can be expanded to 150 vials in combination with an AOC-20s U autosampler. Though the AOC-20i Plus offers exceptional cost-effectiveness for broad market appeal, it also features extensive functionality making it applicable for a variety of applications, such as for co-injecting derivatizing agents.



AOC-20s U

AOC-30i

AOC-20i Plus

(Detailed product brochure: C180-E096, C189-E021)

### Consumables

These consumables are for both AOC-30i and AOC-20i Plus models. They are used to fasten the syringe to the autoinjector. If replacing a syringe, replacing the plunger holder is recommended.

#	Description	P/N	Remarks
(1)	Plunger Holder Screw	037-02759-56	
(2)	Plunger Holder	221-45177-91	Set of 5
(3)	Barrel Holder	221-45178-91	Set of 5
(4)	Barrel Clip	221-48989-91	

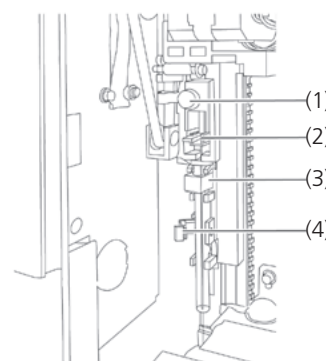

### Options

The 2D code reader reads the two-dimensional code or barcode affixed to sample vials and enters that data in the workstation. That improves traceability by eliminating errors from hand-writing information or manual data entry processes.

The sample cooling fan cools samples down close to room temperature.

A cooling/heating unit can be used to cool or warm samples to a temperature other than room temperature.

Cooling/heating units can control the temperature of sample vials to any temperature within the 0 to 60 °C range by circulating temperature-controlled liquid through the racks.

With AOC-20i Plus models, the number of sample, solvent, or liquid waste vials can be increased by installing expansion parts.

	Description	P/N	Remarks
AOC-30i/ AOC-20s U	Barcode/2D Code Reader for AOC	221-85900-58	Reads barcodes or 2D codes on labels affixed to vials.
AOC-20i	Sample Cooling Fan	221-44995-91	
	Long Turret	221-45622-91	
	Large Vial Holder	221-32949-01	1 case included standard
	4mL Vial Holder, Sampler	221-45182	1 case included standard
AOC-20s U	Cooling/Heating Unit for 1.5mL Vial	221-85189-43	
	Cooling/Heating Unit for 4.0mL Vial	221-85189-44	



(5) Barcode/2D Code Reader

## Gas Sampler MGS Series

These are manual injection valves for injecting gas samples. MGS-2030/2010 models include purged housing that reduces the amount of air leakage during switchover. The MGS-5 includes a valve that can switch between three sample quantity levels, whereas the MGS-2030/2010/4 models change the quantity by selecting a measuring tube. The unit is connected between the sample injection unit and AFC unit, so the sample injection unit can continue to be used. A heating function is not included.

Connectors: Shimadzu MM type or 6 mm tubing joint

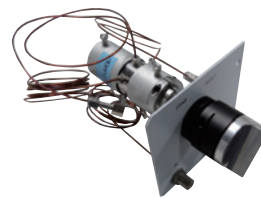

MGS-2010 Valve Unit

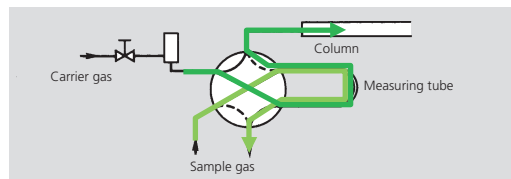

#	Description	P/N	Remarks
-	Sample Loop 0.2mL	225-21889-82	For concentrated or adsorptive components
-	Sample Loop 1mL	225-21889-81	For low to medium concentrations at standard volumes
-	Sample Loop 3mL	225-22046-81	For large injection volumes
(1)	Tubing Joint	201-30254-91	For rubber or plastic tubing with 5 mm I.D.



(1) Tubing joint

## Injection Splitter

This injection unit can split samples without passing them through a standard split/splitless injection port. Air ingress can be reduced by using an injection splitter to connect the gas sampler and column.

## Headspace Sampler HS-20 Series

With short transfer lines and patented isolation gas technology, HS-20 NX series headspace samplers reduce carryover to one-tenth the level of previous models and significantly increase laboratory productivity. The ability to overlap processing of up to 12 vials makes the samplers especially useful in fields that require high throughput. Featuring the world's only\* electronically-cooled trap, the HS-20 NX Trap enables over ten times higher sensitivity than regular headspace analysis. The product line also includes an HS-20 Long Transfer Line (LT) model compatible with packed columns. The HS-10 is a low-cost entry model with stirring and overlapping functionality for outstanding cost-effectiveness.



Nexis GC-200 + HS-20 NX (Loop model)

(Detailed product brochure: C180-E094)

\* As of August 2021, according to a Shimadzu survey

### Option

#	Description	P/N	Remarks
-	Barcode Reader for HS-20	225-23340-41	Reads barcode labels affixed to vials.

### Needle for HS-20

#	Description	P/N	Remarks
(1)	Deactivated Needle, 0.4mm ID	225-11238-41	For reducing surface area
-	Deactivated Needle, 0.6mm ID	225-11238-43	Standard needle
-	Deactivated Needle, 0.8mm ID	225-11238-44	Prevents clogging when measuring samples with precipitating salts
-	Acid-resistant Needle, 0.4mm ID	225-32168-42	For analyzing blood with acid added
-	Needle, 0.4mm ID	225-11238-42	Low-cost needle



HS-10 + GC-2014

(Detailed product brochure: C180-E081)

### Sample Loop

#	Description	P/N	Remarks
-	Sample Loop 0.2mL	225-21889-82	For concentrated or adsorptive components
-	Sample Loop 0.4mL	225-21889-83	For volume compatibility with HSS-2/4 series models
-	Sample Loop 0.5mL	225-21889-85	For concentrated or adsorptive components
-	Sample Loop 0.8mL	225-21889-84	For volume compatibility with HSS-2/4 series models
(2)	Sample Loop 1mL	225-21889-81	For low to medium concentrations at standard volumes
-	Sample Loop 2mL	223-54697-04	For large injection volumes
-	Sample Loop 3mL	225-22046-81	For large injection volumes



(1) Deactivated Needle, 0.4mm ID



(2) Sample Loop 1mL

### Other Consumables

#	Description	P/N	Remarks
-	Rotor, SSAC6WE	040-28090-50	Use this for temperature ranges not suitable for the SSAC6WT model. The upper limit is 225 °C at 400 psi
-	Clean GVF Socket, 6.0	225-41074-03	For ClickTek NX, Set of 10



### Trap Tube for HS-20 and TD-30

#	Description	P/N	Remarks
(2)	Trap Tube TenaxTA	225-23328-41	For measuring C4 to C44 medium-to-high boiling components
-	Trap Tube Carboxen1000	225-23328-42	For measuring C2 to C16 low-to-medium boiling components
-	Trap Tube TenaxTA+ Carboxen1000	223-54144-92	For measuring working environments, including MeOH
-	Trap Tube Carboxen1000	223-54144-96	Universal model that supports low-to-high boiling points
-	Trap Tube CarboxenY	223-54144-97	Similar properties to TenaxTA, but fewer decomposition products
-	Nut, 1/8-Inch	035-62902-01	1/8 Swagelok
-	SS-200 Sleeve Set	035-62972-02	1/8 Swagelok
-	Ferrule GV 1/8"	223-54423-91	For HS trap model and TD, set of 2



(2) Trap Tube TenaxTA



Rotor, SSAC6WT

### Other Consumables

#	Description	P/N	Remarks
-	Rotor, SSAC6WT	040-28090-25	This is the standard rotor. The seal material has a tendency to stick to the valve body at 150 °C or lower temperatures (250 °C or higher recommended).

## Thermal Desorption System TD-30 Series

The TD-30 series was developed to offer solutions optimized for gas and material analysis applications. With no cold points along the sample path, it enables trace analysis of high-boiling-point components required for analyzing emission gases. The practical retrapping function supports a wide range of boiling points to reduce the risk of analytical losses when measuring atmospheric air or work environments. Functionality for automatically adding internal standard substances enables higher reproducibility than manual injection. An optional barcode reader can read barcodes printed on tubes. The series includes a TD-30 model with a 60-sample loading capacity and a TD-30R model with a 120-sample capacity and functionality for retrapping and adding internal standard substances. The series supports a wide variety of analysis applications, from R&D to quality control.



Nexis GC-2030 + TD-30

(Detailed product brochure: C146-E349)

### Option

#	Description	P/N	Remarks
-	Barcode Reader for TD-30	225-32325-41	Reads barcodes from tubes labeled with a printed barcode.

### Sample Tube

#	Description	P/N	Remarks
(1)	Trap Tube TenaxTA 130mg	223-57102-91	For measuring C4 to C44 medium-to-high boiling components and ideal for measuring indoor air or emission gases
-	Trap Tube TenaxGR 130mg	223-52284-91	Made of TenaxTA with graphite added for use in the semiconductor industry
-	Trap Tube TenaxTA 100mg+ Carboxen1000 50mg	223-52884-91	Universal model that supports low-to-high boiling points
-	Trap Tube Carboxen B 130mg+ Carboxen1000 100mg	223-57474-91	For measuring low-boiling components, such as hazardous air pollutants or working environments
-	Glass Tube	223-57119	For direct thermal desorption with the tube filled with plastic or other solid samples
-	Tube Cap	223-54617-41	Caps only for TD-20/30 series, set of 20



(1) Trap Tube TenaxTA 130mg

Note: Shimadzu brand sample tubes are not barcoded. Barcoded sample tubes are available for Shimadzu TD from Sigma-Aldrich (Merck) or GL Sciences (CAMSCO).

### Other Consumables

#	Description	P/N	Remarks
-	O-ring AS568A009 7075UP	036-15680-09	Heat resistant O-ring
-	O-ring PTFE coating	223-57166-91	For room temperature, for cap, set of 20

# Sample Injection Unit

## Split/Splitless Sample Injection Unit (SPL)

An AFC digital flow controller accurately controls split ratios and the flowrate and linear velocity through columns.

The split analysis allows specifying a linear velocity suitable for separation, but that increases carrier gas consumption due to higher gas flowrates.

However, using the carrier gas saver function can reduce gas consumption by automatically reducing the gas flowrate whenever samples are not being analyzed.

The SPL-2030/SPL-U model is equipped standard with a ClickTek nut that enables single-step insert replacement and helps shorten downtime. The SPL-2030/SPL-U model with deactivated surfaces is also available for samples with highly adsorptive components, such as sulfur-based components.



SPL-2030



Flow Controller AFC-2030

## Wide-Bore Injection Unit (WBI)

This capillary column injection unit is used to inject the total volume of samples through a column with a 0.53 mm internal diameter. Injecting larger sample volumes can increase sensitivity. A septum purge line on top of the injection unit reduces contamination and inhibits tailing of large peaks, such as for solvents.

## Single Packed Injection Unit (SINJ)

This injection unit is for single flow line type packed columns.

It is used to prevent ghost peaks and contamination by using a specialized sample injection unit for a selective detector (such as an ECD). A capillary column with a 0.53 mm internal diameter can also be attached using a WBC attachment kit.

## Dual Packed Injection Unit (DINJ)

This injection unit is for dual flow line type packed columns.

It is included standard with GC-2014 models for packed column analysis.

Dual flow lines enable chromatograms to be obtained while reducing baseline impacts during temperature-programmed analysis.

A capillary column with a 0.53 mm internal diameter can also be attached using a WBC attachment kit.

## WBC Attachment Kits

These attachment kits are used for total sample volume injection through a 0.53 mm internal diameter capillary column attached to a packed injection unit.

Description	P/N	Applicable Models	Remarks
WBC Attachment Kit	221-29992-91	GC-2014	This kit is used to attach a 0.53 mm internal diameter column to a DINJ or SINJ unit and packed detector unit. Make-up gas must be supplied by a flow controller.
	221-29992-93	Nexis GC-2030	This kit is used to attach a 0.53 mm internal diameter column to SINJ and packed detector units.
WBC Adapter for Injection Port	221-29676	All GC models	This adapter is used to attach a 0.53 mm internal diameter column to a DINJ or SINJ unit.
WBC Adapter for DFID/DTCD	221-70952-91	GC-2014	This adapter is used to attach a 0.53 mm internal diameter column to a DFID or DTCD unit. It includes tubing for supplying make-up gas from the DAFC unit.

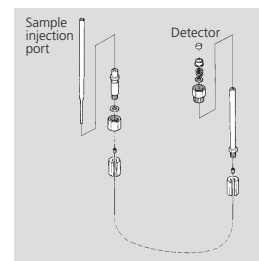

## On-column Injection (OCI) Unit

On-column injection units are suitable for analyzing compounds with thermal instability (easily decomposed). A special syringe is used to inject the total volume of liquid sample directly into the column while the injection unit temperature is below the solvent boiling point, and then the injection unit is heated to vaporize the solvent for analysis. It can reduce decomposition or distillation phenomena (discrimination) within the injection unit.

If using a narrow-bore column or concerned about column contamination, a 0.53 mm internal diameter guard column (deactivated) can be connected by Press-Tight connectors. By using an easy OCI insert, a narrow-bore column can be used directly connected by Press-Tight connectors. (OCI-2030NX models do not support easy OCI injection.) For inserts for simplified OCI and parts to connect pre-column and main column, see Column Connection Parts (p. 13).

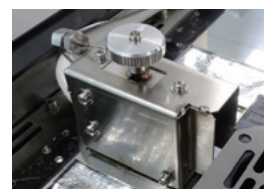
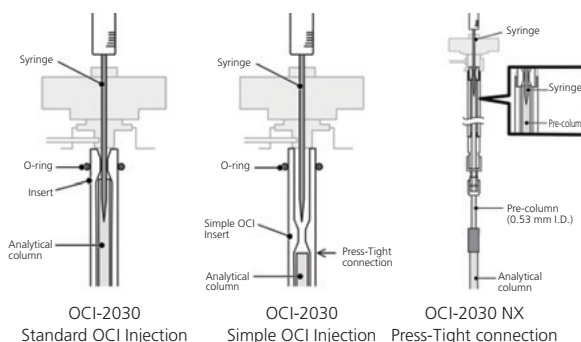

## Programmed Temperature Vaporization (PTV) Injection Unit

Programmed temperature vaporization injection units are suitable for analyzing compounds with thermal instability (easily decomposed) because there is no distillation phenomenon (discrimination).

Programmed temperature vaporization (PTV) is an analysis method that injects liquid samples into the insert to enable both split and splitless methods.

Using an insert reduces column contamination.

It can also be used for high-sensitivity analysis by injecting a large sample volume and then concentrating the target components inside the injection unit by heating the solution to a temperature that only vaporizes the solvent and discharging the solvent via the split line.

## Septum Nut

#	Description	P/N	Applicable models and remarks
(1)	Septum Nut with Needle Guide for SPL	221-77117-41	Nexis GC-2030, Brevis GC-2050 Needle guide not necessary
(2)	Septum Nut	221-87977-02	GC-2010 Plus (for SPL)
	Septum Nut	221-41286	GC-2010 Plus (for WBI/OCI), GC-2014, or GC-2025
(3)	Septum Nut for Packed INJ	221-89210-02	Nexis GC-2030 and GC-2014 (for packed INJ units)
(4)	Needle Guide	221-44584	Nexis GC-2030 (for packed INJ units)
	Needle Guide	221-44823-91	For GC-2010/2010 Plus, GC-2014, or GC-2025 Set of 2
(5)	Injection Port Spacer	221-22206	Nexis GC-2030 and GC-2014 (for packed INJ units)

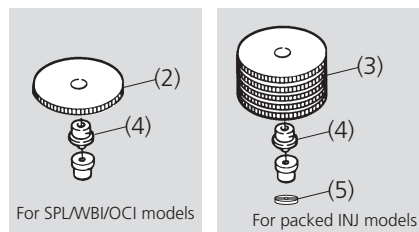
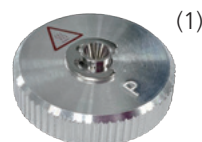

## ClickTek Nuts (For Single-Step Replacement)

ClickTek nuts are included standard with SPL-2030 and WBI-2030 models. They cannot be installed in other injection units.

## Parts for Connecting Capillary Columns

The parts used to connect capillary columns are determined based on the column's internal diameter, whether or not air ingress via the connector would affect analysis, and whether or not ClickTek connectors are used.

	Adapter	Graphite	Vespel	ClickTek
HS-20 NX	Split joint		✓	✓
HS (except HS-20 NX) or TD	Split joint		✓	
Sample Injection Units (when using SCD or GC-MS)	Vespel adapter		✓	
SPL/WBI	Capillary adapter (included standard)	✓	✓	✓
PTV	Capillary adapter (included standard)	✓		
OCI	Not necessary or Press-Tight connector			
SINJ	Stainless steel column adapter (included standard) or WBC adapter	✓		
DINJ	Stainless steel column adapter (included standard) or WBC adapter	✓		
SCD, GCMS	Vespel adapter		✓	
FID, TCD, BID, FPD, FTD, ECD	Capillary adapter (included standard)	✓		✓
PFID, PTC	Stainless steel column adapter (included standard) or WBC adapter	✓		

## Nuts and Graphite Ferrules for Capillary Columns

These are typical graphite ferrules. They are easy to use and somewhat reusable. They can be used at temperatures up to 450 °C. Due to oxygen permeability, they are not suitable for GC-MS systems or for analyzing target compounds that contain oxygen.

#	Description	P/N	Remarks
(1)	Gold Gasket	221-49065-91	Set of 5
(2)	Capillary Adapter	221-42998	
-	Deactivated Capillary Adapter	221-82787-04	Deactivated
(3)	Back Washer	201-30051	
(4)	Nut	201-30008	
(5)	Ferrule, 0.5 mm	221-32126-05	For columns with O.D. up to 0.5 mm, set of 10
(5)	Ferrule, 0.5 mm Conditioning	227-35006-01	For columns with O.D. up to 0.5 mm, pre-aged, and suitable for temperature-programmed analysis, set of 10
(5)	Ferrule, 0.8 mm	221-32126-08	For columns with O.D. up to 0.8 mm, set of 10
(5)	Ferrule, 0.8 mm Conditioning	227-35009-01	For columns with O.D. up to 0.8 mm, pre-aged, and suitable for temperature-programmed analysis, set of 10
-	Column Nut with Slit	221-32705-84	For detector, set of 5
(6)	Column Nut without Slit	221-16325-81	For sample injection unit, set of 10

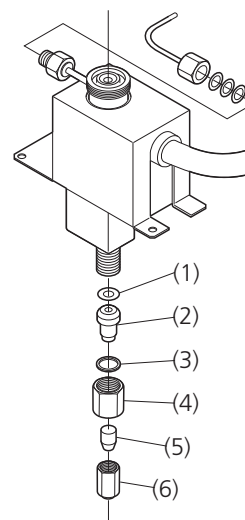

## Nuts and Vespel Ferrules for Capillary Columns

If air ingress via the connector could affect analysis, using Vespel ferrules with dedicated adapters/nuts is recommended. Additional tightening is required so they cannot be reused for any other column than the one to which it is initially tightened. Use them at temperatures up to 325 °C.

#	Description	P/N	Remarks
(2)	Capillary Adapter	225-10167-91	Adapter (for MS injection port), pre-washed
(5)	Ferrule: GVF-004	670-15003-03	For 0.25 mm columns
(5)	Ferrule: GVF-005	670-15003-04	For 0.32 mm columns
(5)	Ferrule: GVF-008	670-15003-07	For 0.53 mm columns
(6)	Column Nut, 1/16"	670-11009	Nut (for SCD/MS/HS/TD units), set of 5

Note: Not compatible with metal capillary columns

## ClickTek Nuts and Ferrules for Capillary Columns

These parts enable easy tool-free connection/disconnection for compatible sample injection units and detectors. They are not oxygen permeable, will not generate debris, and will not adhere to the sample injection unit or detector. Use them at temperatures up to 350 °C.

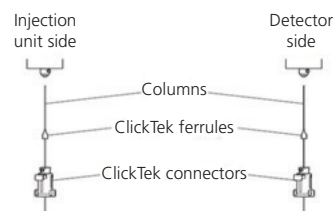

Description		P/N	Applicable Models	Remarks	
ClickTek Starter Kit	AF	221-77144-01	Nexis GC-2030 AF	This kit is required for newly installing ClickTek connectors.	
		221-77144-04	GC-2010 Plus AF/2010 AF		
		221-77144-05	GC-2025AF		
	AT	221-77144-42	Nexis GC-2030 AT		
		221-77144-46	GC-2010 Plus AT/2010 AT		
	ATF	221-77144-43	Nexis GC-2030 ATF		
		221-77144-47	GC-2010 Plus ATF/2010 ATF		
	SPL	221-77144-11	Nexis GC-2030		This kit is for supporting ClickTek connectors with an SPL/WBI unit installed.
		221-77144-21	GC-2010 Series		
	FID	221-77144-12	Nexis GC-2030		This kit is for supporting ClickTek connectors with an FID unit installed.
		221-77144-22	GC-2010 Series, GC-2025		
	BID	221-77144-53	Nexis GC-2030, GC-2010 Series		This kit is for supporting ClickTek connectors with a BID unit installed.
FTD	221-77144-57	This kit is for supporting ClickTek connectors with an FTD unit installed.			
FPD	221-77145-15	Nexis GC-2030, Brevis GC-2050, GC-2010 Series	This kit is for supporting ClickTek connectors with an FPD unit installed.		
ECD	221-77144-56	Nexis GC-2030, GC-2010 Series	This kit is for supporting ClickTek connectors with an ECDeceed unit installed.		
	221-77144-58	Brevis GC-2050			
ClickTek Ferrule	Without Holes	211-81162-00	-	Ferrule for blocking flow. (set of 6)	
	0.43m	211-81162-01	-	ClickTek ferrules for columns with up to 0.25 mm I.D. (set of 6)	
	0.50m	211-81162-02	-	ClickTek ferrules for columns with up to 0.32 mm I.D. (set of 6)	
	0.73m	211-81162-03	-	ClickTek ferrules for columns with 0.45 to 0.53 mm I.D. (set of 6)	
ClickTek Connector		221-77155-41	-	To connect multiple columns, two ClickTek connectors are required per column.	
Prefix Tool for GC, ClickTek		221-76547-43	-	Tool used to fasten ClickTek ferrules to columns.	

## Column Connection Parts

SMI Unions are characterized by low leakage, inertness, low dead volume and low heat capacity. Select appropriate components according to the inner diameter of the column to be connected.

- E 0.25mm i.d. column : 0.4\*
- E 0.32mm i.d. column : 0.5\*
- E 0.53mm i.d. column : 0.8\*

\* Inner diameter of ferrule for SMI union (mm)

#	Description	P/N	Remarks
-	Press-Tight Connector	221-38102-92	For connecting 0.25 to 0.53 mm I.D. columns
(1)(2)(3)	SMI Union Kit	0.4 - 0.4	227-35024-01
		0.4 - 0.5	227-35024-02
		0.4 - 0.8	227-35024-03
		0.5 - 0.5	227-35024-04
		0.5 - 0.8	227-35024-05
		0.8 - 0.8	227-35024-06
(1)	Ferrule for SMI Union	0.4 - 0.4	227-35025-01
		0.4 - 0.5	227-35025-02
		0.4 - 0.8	227-35025-03
		0.5 - 0.5	227-35025-04
		0.5 - 0.8	227-35025-05
		0.8 - 0.8	227-35025-06
(2)(3)	SMI Union	0.4 - 0.5 / 0.4 - 0.5	227-35026-01
		0.4 - 0.5 / 0.8	227-35026-02
		0.8 - 0.8	227-35026-03

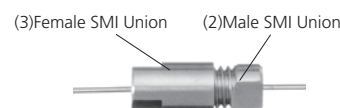
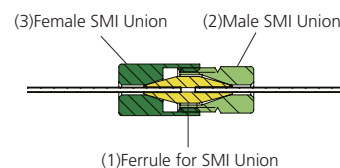





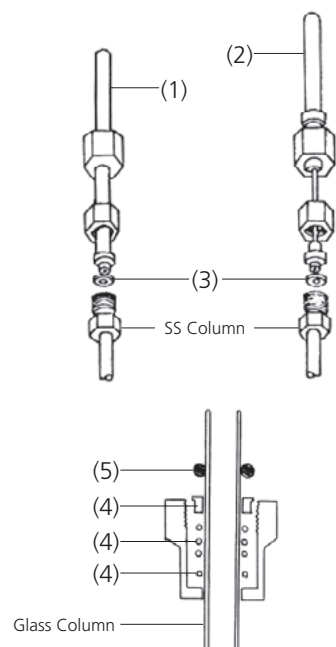

## Parts for Connecting Packed Columns

The parts used to connect packed columns are determined based on the type of column.

#	Description	P/N	Remarks
(1)	Stainless Column Adapter, SINJ	221-14087-92	For stainless steel columns and Nexis GC-2030/GC-2010 series models
(1)	Stainless Column Adapter, INJ	221-14087-91	For stainless steel columns and GC-2014 models
(2)	Stainless Column Adapter, DET, 2030/2010	221-43143-92	For stainless steel columns and Nexis GC-2030/GC-2010 series models
(2)	Stainless Column Adapter, DET, 2014	221-08882-91	For stainless steel columns and GC-2014 models (except TCD)
(2)	Stainless Column Adapter, TCD, 2014	221-10079-93	For stainless steel columns and GC-2014 models (TCD)
(3)	Aluminum Gasket	201-35183-84	For stainless steel columns and high temperatures (250 °C or higher), 5 bags of 100 each
(3)	Silicon Gasket	201-35184	For stainless steel columns used at less than 250 °C, set of 50
(4)	Glass Column Joint Set	221-15561-84	Glass column connection parts, set of 5
(4)	Column Connector, TCD-2014	221-10078-92	For WBC and glass columns
(5)	Graphite Ferrule for Glass Columns	221-15563-91	For glass columns and high temperatures (250 °C or higher), set of 4
(5)	TCD Sleeve Ferrule	221-10076-91	For TCD-2014 glass and stainless steel columns, set of 10
(5)	O-ring Silicon	201-47614	For glass columns used at less than 250 °C, set of 20



## Injection Port Septa

Description	P/N	Color	Features
 <b>Xtra Life Septum</b> (25 pcs)	227-35511-01 	Brown	Unique two-piece design ensures a leak-free seal and minimizes particulates generated from repeat injections. Ideal for trace-level analysis and lasts up to 10 times longer than standard septa. <ul style="list-style-type: none"> <li>• Maximum temperature (INJ setting temperature): 400 °C</li> </ul>
 <b>Premium Green Septum</b> (50 pcs)	227-35004-01  For Nexis GC-2030 and Brevis GC-2050	Green	This low-bleed septum is heat resistant. It helps inhibit components bleeding even during high-sensitivity analysis. Made of crack-resistant material, it offers superior durability, sealing performance and solvent-resistance. <ul style="list-style-type: none"> <li>• Maximum temperature (INJ setting temperature): 350 °C</li> </ul>
 <b>Standard type</b> (20 pcs)	201-35584  For except Nexis GC-2030 and Brevis GC-2050	White	General-purpose septum

## Other Injection Port Septa

#	Description	P/N	Color	Features
(1)	HT Septum (20 pcs)	221-48398-91	Brown	<ul style="list-style-type: none"> <li>• Suitable for high-sensitivity analysis at high temperatures</li> <li>• Maximum temperature (INJ setting temperature): 450 °C</li> </ul>
(2)	LL Septum (20 pcs)	221-48972-91	Blue	<ul style="list-style-type: none"> <li>• Suitable for high-sensitivity analysis</li> <li>• Maximum temperature (INJ setting temperature): 450 °C</li> </ul>
(3)	Enduro Blue Septum (50 pcs)	221-75180	Light blue	<ul style="list-style-type: none"> <li>• Low-bleed</li> <li>• Maximum temperature (INJ setting temperature): 350 °C</li> </ul>

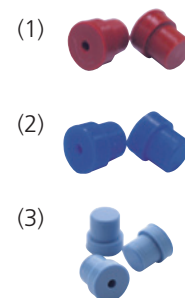

A low-bleed septum is not completely free of bleeding. The type of bleeding that occurs varies with the septum and results in different patterns on chromatograms. In the case of high-sensitivity analysis, it is necessary to select a septum whose bleeding will not occur at a point that interferes with the peak of the target compound. Conditioning for several hours between 120 °C and 200 °C after extraction with hexane may help to reduce bleeding. In the case of using a syringe for AOC, it is recommended to exchange the septum after about 100 injections. If the outside diameter of a needle of a gastight syringe is thick, it is recommended to exchange after about 50 injections.

# Column Oven Accessories

## Cryogenic Valve Unit (CRG)

The CRG supplies refrigerant (liquified carbon dioxide gas or liquid nitrogen) to the GC for controlling the column oven temperature below room temperature. Refrigerant supply is controlled by switching an electromagnetic valve ON or OFF. Temperature is controlled to -50 °C if using liquified carbon dioxide as a refrigerant or to -99 °C if using liquid nitrogen. It is used for detailed analysis of hydrocarbons (DHA) or cryogenic separation of inorganic gases (argon, oxygen, etc.) as specified by ASTM and JIS standards. Placing the refrigerant container near the GC is recommended.

---

## Oven Light

Illuminating the GC column oven interior makes it easier to see connections when routing the column to the injection port or detector. It helps prevent damage from hitting the column tip against objects.



---

## Column Hanger

These parts are used to secure columns inside the column oven. They can secure 1 to 3 columns, depending on the column shape.

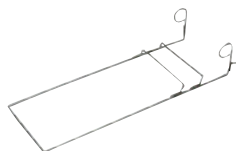

---

## Oven Insert

The heating rate can be increased by installing an oven insert inside the column oven. Due to the shorter analysis times resulting from faster heating, the insert is used for applications such as simulated distillation (SimDis) gas chromatography and total petroleum hydrocarbons (TPH) analysis.

Note: Some restrictions apply regarding where the sample injection unit or detector can be installed and how many columns can be installed.

---

## Exhaust Duct

Due to the hot gases discharged from the back of the GC, the back of the GC must be kept a certain distance from any wall in order to prevent trapping heat. If the required space cannot be provided, install an L-shaped exhaust duct. If an exhaust duct that can be connected directly to a 100 mm diameter spiral duct is used, then the oven exhaust can be discharged directly into an exhaust ventilation system to minimize any increase in room temperature.



# Detectors

## Flame Ionization Detector (FID)

This general-purpose detector can detect almost all organic compounds (except formaldehyde and formic acid). Sensitivity to changes in temperature or gas flowrates is poor, but it offers high S/N ratios and a wide dynamic range, and is easy to use for a wide range of applications.

### FID Nozzles and Collectors

If using an FID, better or more reliable analysis results can be obtained for some samples by replacing the nozzle or collector. The larger the nozzle bore diameter, the less prone it is to sample clogging and the more linear the results, but the lower the sensitivity. Nozzle designs are optimized for the main analytical target.

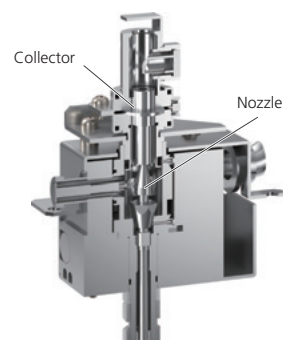

Flame Ionization Detector (FID-2030)

#	Applicable Models	Description	P/N	Remarks
(1)	Nexis GC-2030 Brevis GC-2050	Nozzle, Capillary, FID-2030	221-75597-03	This standard nozzle is used for capillary columns.
		Nozzle, Wide, FID-2030	221-75597-05	It is used to measure a wide range of concentrations via a capillary column with a 0.53 mm I.D.
		Nozzle, Aqueous, FID-2030	221-75597-08	It is used if the hydrogen flame is prone to extinguishing when analyzing aqueous or other solutions via a capillary column or if the nozzle is prone to clogging when analyzing high-boiling components.
(2)	GC-2010 Series GC-2025	Nozzle, Capillary, FID-2010/2025	221-48258-91	This standard nozzle is used for capillary columns.
		Nozzle, Wide, FID-2010/2025	221-48258-92	It is used to measure a wide range of concentrations via a capillary column with a 0.53 mm I.D.
		Nozzle, Aqueous, FID-2010/2025	221-49373-91	It is used if the hydrogen flame is prone to extinguishing when analyzing aqueous or other solutions via a capillary column or if the nozzle is prone to clogging when analyzing high-boiling components.
(3)	Nexis GC-2030	Nozzle, Packed, FID-2030	221-85179-41	This standard nozzle is used for packed columns.
		Nozzle, Packed Aqueous, FID-2030	221-85179-42	It is used if the hydrogen flame is prone to extinguishing when analyzing aqueous or other solutions via a packed column.
(4)	GC-2014	Nozzle, Packed, FID-2014	221-70162-95	This standard nozzle is used for packed columns.
		Nozzle, Aqueous, FID-2014	221-70162-96	It is used if the hydrogen flame is prone to extinguishing when analyzing aqueous or other solutions via a packed column.
(5)	GC-2014	Nozzle, Capillary, FID-2014	221-70162-93	It is used for high-sensitivity measurements using a capillary column.
		Nozzle, Wide, FID-2014	221-70162-92	This standard nozzle is used for capillary columns.
		Nozzle, Aqueous, FID-2014	221-70162-94	It is used if the hydrogen flame is prone to extinguishing when analyzing aqueous or other solutions or if the nozzle is prone to clogging when analyzing high-boiling components.
(6)	GC-2010 Series	Nozzle, Packed, FID-2010	221-48885-91	This standard nozzle is used for packed columns.
(7)	Nexis GC-2030	Collector, FID-2030	221-72322-95	
	Nexis GC-2030	Collector, Wide, FID-2030	221-72322-96	Used with an FID nozzle collector kit.
	Brevis GC-2050	Collector, FID-U	221-87525-41	
		Collector, Wide, FID-U	221-87659-41	Used with an FID nozzle collector kit.
	GC-2010 Series GC-2025	Collector, FID-2010/2025	221-72322-91	
(8)	GC-2014	Collector, FID-2014	221-81021-41	
	Nexis GC-2030	FID Custom Kit for Wide Concentration Ranges	221-88280-41	It is used to measure a wide range of concentrations. Configured with a 0.5 mm diameter capillary nozzle and FID-2030 wide collector.
	Brevis GC-2050	Nozzle Collector Kit, FID-U	221-88280-46	It is used to measure a wide range of concentrations. Configured with a 0.5 mm diameter capillary nozzle and FID-U wide collector.
	Nexis GC-2030	FID Custom Kit for Packed Columns	221-85191-41	It is used to connect a packed column to an FID-2030 detector.
	GC-2014	Capillary Adapter for DFIDs	221-33193-91	It is used to connect a capillary column to an FID-2014 detector.



(1) Capillary Nozzle for GC-2030 and GC-2050



(2) Capillary Nozzle for GC-2010 and GC-2025



(3) Packed Nozzle for GC-2030



(4) Packed Nozzle for GC-2014



(5) Capillary Nozzle for GC-2014



(6) Packed Nozzle for GC-2010



(7) FID-2030 Collector



(8) FID-2014 Collector



## Thermal Conductivity Detector (TCD)

Featuring simple construction and operability, this general-purpose detector should be able to detect all substances with a thermal conductivity that is different from the carrier gas.

It is mainly used to detect inorganic gases or components without FID detection sensitivity. Because it is a non-destructive detector, it can be connected in series with other detectors.

Helium is primarily used as the carrier gas. (N<sub>2</sub> or Ar is used to analyze He or H<sub>2</sub>.)

### Capillary Adapter for TCD

This is used to supply make-up gas, such as via a split tube connected to a packed column injection port. It is used to connect a capillary column to a packed column TCD unit.



## Barrier Discharge Ionization Detector (BID)

BIDs enable detecting every compound except Ne (neon) and He, which is plasma gas, with high sensitivity (ppm). Therefore, BIDs enable analyses of CO, CO<sub>2</sub> and light hydrocarbons simultaneously with high sensitivity, while these mixed gas samples require multiple detectors using conventional analytical methods.

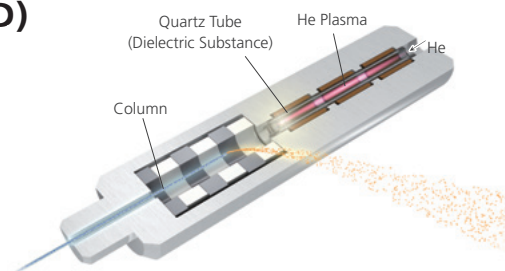

## Helium Purifier HP-2

This purifier can purify helium supplies with up to 10 ppm impurities (equivalent to a G2 helium cylinder) to achieve a purity level of up to 10 ppb impurities.

That means it can supply helium for BID units that require a minimum 99.9999 % purity.

It can purify helium at flowrates up to 1000 mL/min.



## Jetanizer

Jetanizer is a compact FID nozzle type methanizer. The inside of the FID nozzle is filled with a reduction catalyst. By reacting with hydrogen, CO and CO<sub>2</sub> can be converted to CH<sub>4</sub> with high efficiency, enabling highly sensitive detection with FID.

It can be used by simply changing the nozzle of the existing FID-2030/FID-2010. It can be installed at low cost without requiring additional power.

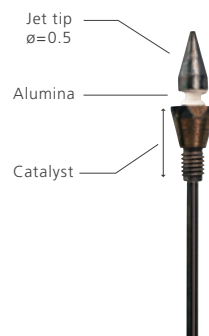

Name	P/N	Remarks
Jetanizer for GC-2030	220-94673-30	For Nexis GC-2030 and Brevis GC-2050 models

## Electron Capture Detector (ECD)

ECDs provide extremely high selective sensitivity to halogen and nitro compounds by using a radioisotope. They offer especially high sensitivity for chlorinated compounds, enabling detection at the picogram quantity level, making them ideal for the trace analysis of chlorinated pesticide residues. To ensure a stable baseline, supply gas (especially nitrogen) must be free of oxygen.

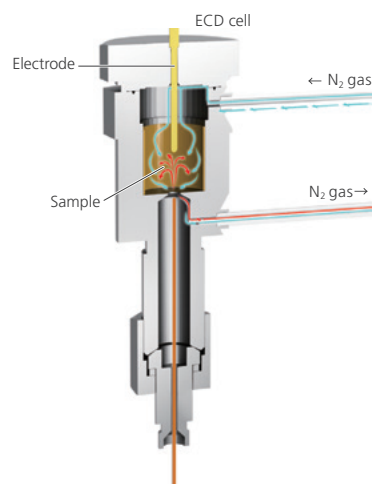

Applicable GC Models	Nexis GC-2030 (ECD-2010 Exceed)	Brevis GC-2050 (ECD-2010 Exceed U)	GC-2010 Plus (ECD-2010 Exceed)	GC-2010/2010 Plus (ECD-2010 Plus)	GC-2014 (ECD-2014)
ECD Control Unit	221-77540-41/42	221-87610-41	221-77550-41/42	221-47733-41/42	221-75032-41/42/44
ECD Cell	221-77510-41	221-87505-58	221-77510-41	221-72002-91	221-72001-91

Note: Due to the need for radioactive material management, the ECD cell is sold separately.

### ECD Flow Bypass Kit

Equipped as standard on the Nexis GC-2030 and Brevis GC-2050.

It is an option (photo on the right) for the GC-2010 series. Gas continues to flow into the ECD cell even when the power is turned off, allowing the baseline to stabilize quickly when the power is turned on.



## Sulfur Chemiluminescence Detector (SCD)

This selective high-sensitivity detector measures the sulfur content in samples based on its chemiluminescence.

It enables about one order of magnitude higher sensitivity than FPD detectors that selectively detect sulfur compounds in a similar way; however, it differs from FPD detectors in that sensitivity is linearly proportional to sample concentration. (FPD sensitivity is quadratically proportional to concentration.) SCD detectors also offer similar molar sensitivity, which enables sulfur compounds to be measured with the same relative sensitivity regardless of their structures.

That characteristic means that a calibration curve for a different compound can be used to determine an approximate concentration, even for compounds without a standard sample available.

It is ideal for analyzing sulfur compounds in natural gas or gasoline or trace flavor components in beverages.



Description	P/N	Remarks
SCD Consumables Set	221-84141-41	This is a set of consumables for six months of operation.
Ozone Scrubber Set	221-84384-41	Ozone scrubber is pre-filled.
Ozone Scrubber Filter	221-84142-41	
DAU-20 Maintenance Kits	221-82894-50	Pump maintenance kit

## Flame Photometric Detector (FPD)

The characteristic light emitted from the combustion of sulfur or phosphorus compounds is selected with an optical filter and detected by a photomultiplier to permit selective detection. FPDs are now extensively used for determination of malodorous compounds such as hydrogen sulfide and methyl sulfide, and determination of residual phosphoric pesticides.

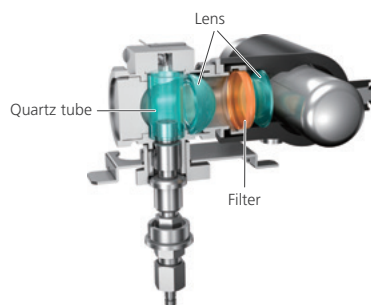

### Interference Filter

Use an appropriate filter (sold separately) for your detection target. Three types, for detecting sulfur, phosphorus, and tin, are available.

#	Description	P/N	Remarks
(1)	FPD Filter for S, 2030	221-80888-01	For Nexis GC-2030
(2)	FPD Filter for P, 2030	221-80888-02	For Nexis GC-2030
(3)	FPD Filter for Sn, 2030	221-80888-03	For Nexis GC-2030
(4)	FPD Filter for S, 2010	221-73354-01	For GC-2010 Series
(5)	FPD Filter for P, 2010	221-73354-02	For GC-2010 Series
(6)	FPD Filter for Sn, 2010	221-73354-03	For GC-2010 Series
-	FPD Filter for S, 2014	221-46310-01	For GC-2014
-	FPD Filter for P, 2014	221-46310-02	For GC-2014
-	FPD Filter for Sn, 2014	221-46310-03	For GC-2014



### Photomultiplier Purge Kit

The service life of expensive photomultipliers can be extended by reducing the amount of helium or other gases entering the photomultiplier to prevent deterioration. The kit is useful for installing a detector that uses helium (FID or FTD) or for simultaneously installing an FPD.



Note: A photomultiplier purge kit is not included standard with FPD-2030 detectors.

## Flame Thermionic Detector (FTD)

This selective high-sensitivity detector detects compounds that contain nitrogen or phosphorus by ionizing the compounds and detecting alkali metal ions in a hydrogen flame. (FPD detectors offer higher selectivity for phosphorus compounds.)

It does not respond to inorganic nitrogen compounds. These detectors can be used for analyzing organic phosphorus compounds or organic nitrogen compounds, such as residual pesticides.

### FTD Nozzles and Collectors

Description	P/N	Remarks
Nozzle, Capillary, FTD-2030/2010Plus/2014C	221-48258-91	For FTD-2030, FTD-2010 Plus, and FTD-2014C models
Nozzle, Packed, FTD-2014	221-70162-92	For FTD-2014 models using a packed column
Nozzle, Capillary, FTD-2014	221-70162-93	For FTD-2014 models using a capillary column
Collector Bead (capillary)	221-71513-91	For FTD-2030, FTD-2010 Plus, and FTD-2014C models
Collector Bead (packed)	221-18704-91	For FTD-2014
Collector Bead (pesticides)	221-42512-91	For FTD-2014. Collector for packed analysis suitable for pesticide analysis
FTD Collector Regeneration Kit	221-49079-91	For FTD-2030, FTD-2010 Plus, and FTD-2014C models This kit is for reusing FTD collectors with decreased sensitivity by adding an alkali source.
FTD Collector Regeneration Adapter	221-70846-91	Using an FTD collector regeneration kit improves productivity.

# Safety and Environmental Accessories

## Hydrogen Carrier Gas Kit

As a safety measure for hydrogen use, we offer a lineup of hydrogen sensors, hydrogen safety options, and more. The hydrogen sensor enables early detection of potential hydrogen leaks inside column ovens and switches to a safe standby mode. It also shuts OFF the main power supply if the hydrogen leak rate increases to prevent accidents.

The hydrogen safety option controls the hydrogen flow rate and hydrogen supply pressure in case a column isn't connected or the flow controller fails. This optional product ensures safer user of hydrogen carrier gas.

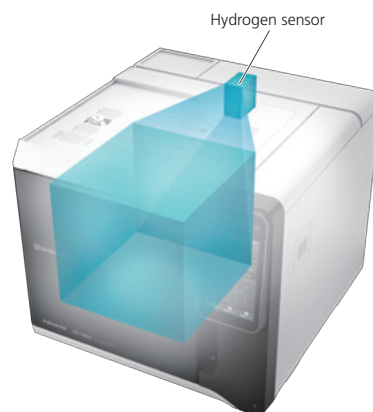

## Supply Gas Shut-off Solenoid Valve Unit

This Solenoid Valve Unit is connected to the detector's supply gas (hydrogen, air). It not only can shut off the supply gas according to instrument power supply or system ON/OFF operation, but also enables automatic startup and shutdown after analysis ends.

Note: Not applicable for FID.

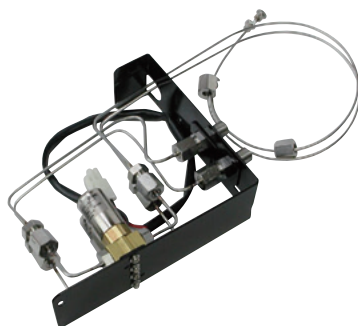

## Parts for Securing Instruments

Securing the instrument with these parts can reduce the risk of the instrument tipping over or falling. GC, SCD, and HS units are secured to a table or stand. AOC units are secured to the top of a GC unit.

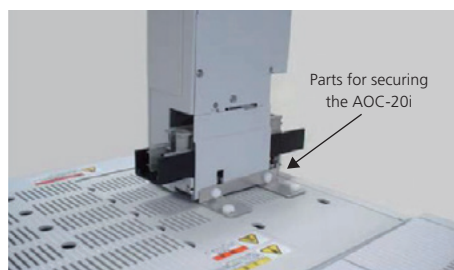

## Vent Tube

If a hazardous gas or hydrogen gas is discharged from the split vent or detector vent, use this silicone rubber tube (6 mm I.D. and 8 mm O.D.) to exhaust the gas into a local exhaust system.



# Gas Utility

## Air Generator AGE-1000

This purifier can purify air supplies with up to 100 ppm impurities to achieve a purity level of up to 100 ppb impurities.

That enables high-sensitivity capillary FID analysis equivalent to using high-purity air supplied from a gas cylinder.

With a maximum air flowrate of 1000 mL/min, it can supply air for two FIDs.

Note: For the AGE-1000, use an oilless air compressor to supply air with microparticles and water moisture removed, such as by using an air filter regulator and silica gel.



(Detailed product catalog: C184-E029)

## Air Compressor

This supplies compressed air with no oil mist for supplying air as auxiliary gas for FID, FPD, or other instruments. In addition to the standard model (55 to 57 dB), a quiet model (47 dB) is available. The recommended flowrate when connected to a GC is 2.5 L/min. It can reliably supply up to four FIDs. However, the actual maximum number of units depends on the given combination, due to differences in the air flowrate required for different detectors. If used for an FTD, the baseline will not stabilize and the specified performance level cannot be guaranteed.



Standard Compressor  
(0.2LE-55B)



Quiet-type Compressor  
(P00.4-LESN)

## H<sub>2</sub> Generator

This compact hydrogen gas generator generates hydrogen by water electrolysis of an ion-exchange membrane. By simply supplying purified water, this unit can conveniently generate high-purity water by electrolysis. However, the purified water supply must be deionized to a specific resistance of 1.0 MΩ·cm or higher.

Description	Output Flowrate	Output Pressure
Precision SL (100 mL/min)	100mL/min	Constant 689/486 kPa
Precision SL (200 mL/min)	200mL/min	
Precision (100 mL/min)	100mL/min	Up to 689 kPa
Precision (200 mL/min)	200mL/min	
Precision (300 mL/min)	300mL/min	
Precision (450 mL/min)	450mL/min	



Precision



Precision SL  
(Space-saving type)

# Gas Filter

If a gas supplied to the GC contains impurities, the impurities could damage the column or detector or cause detrimental effects to analytical results.

Though supplying high-purity gas is important, impurities can also be introduced from the flow lines or other sources between the gas cylinder and GC. Installing an appropriate gas filter can help maximize performance from instruments and ensure reliable analysis.

For split analysis, the split sample flows that bypass the flow controller can cause valve problems. Selecting a suitable filter for the given sample can help ensure worry-free operation in such cases.

Application	Impurities	Effects
Column	Oxygen/moisture	Shortens life of liquid phases. Large impact on polar columns and during high-temperature analysis
FID	Hydrocarbons/moisture	Elevates baseline and increases noise.
TCD	Oxygen	Shortens filament life.
BID	Oxygen/nitrogen	Causes plasma ignition failure. Elevates baseline and decreases sensitivity.
FPD	Hydrocarbons/moisture	Elevates baseline and increases noise.
ECD	Oxygen	Decreases linearity and sensitivity.

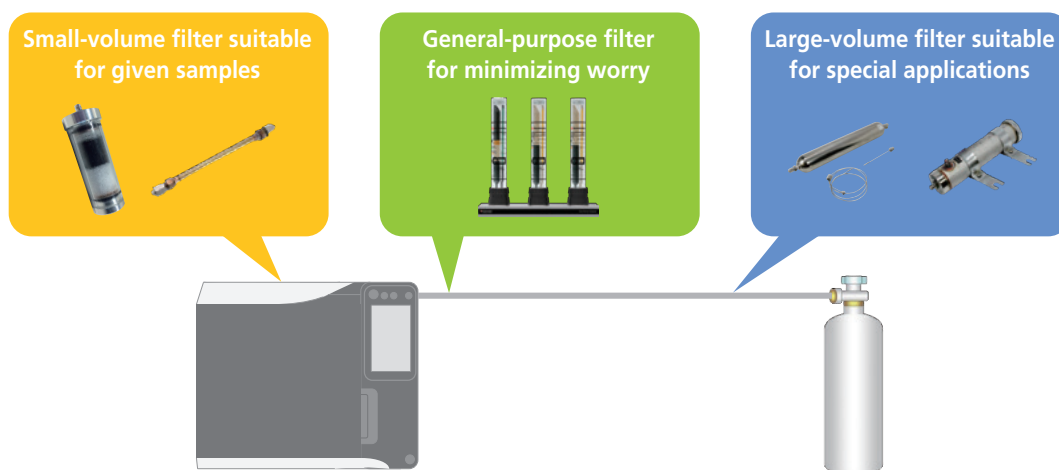

## Super-Clean Gas Filter

These filters can purify supplied gas to 99.9999 % or higher purity levels by adsorbing and removing impurities (such as organic components, moisture, and oxygen) in the gas. They can help reduce analytical instrument downtime by preventing column deterioration due to oxygen, preventing ghost peaks and baseline fluctuations, eliminating excessive detector noise, and so on.

#	Description	P/N	Remarks
(1)	Shimadzu Gas Filter Kit for GC-FID/FPD	227-37036-01	3 ports for FID, FPD, FTD, or SCD units
-	Shimadzu Gas Filter Kit for Compressed Air	227-37036-02	3 ports for FID units with compressor air supplies
-	Shimadzu Carrier Gas Filter Kit	227-37034-02	1 port for carrier gas (TCD or ECD detector gas)
-	Shimadzu Carrier Gas Filter Kit (Helium Replaced)	227-37034-03	1 port for BID units
-	Shimadzu Makeup Gas Filter Kit for Separate Makeup Gas	227-37034-01	1 port for make-up gas (FID, FTD, or ECD) if carrier gas is not used as detector gas
-	Shimadzu Carrier Gas Filter	227-37037-01	
-	Shimadzu Carrier Gas Filter (Helium Replaced)	227-37037-05	
-	Shimadzu Makeup Gas Filter	227-37037-02	
-	Compressed Air Gas Filter	227-37037-03	
-	Gas Filter Kit	227-37038-01	
-	Compressed Air Gas Filter Kit	227-37038-02	
-	O-ring for Base Plate	227-37031-02	



(1) General-Purpose Gas Filter Kit Filter can be installed easily.

**Check Valve**  
The base plate keeps gas flow blocked unless a filter is installed.



(Detailed product catalog: C180-E083)

## Filter Regulator

For high-sensitivity analysis, this regulator reduces baseline fluctuations caused by compressor pressure pulsation or supplied pressure fluctuations when using a central piping system.

It also removes water and contaminant particles from gas supplies. It can be used repeatedly by manually discharging collected substances.



## Filter Joint

This is a sintered filter in the form of a union joint. Its ability to remove foreign matter is useful for connecting to new pipes or other situations where cleanliness is not ensured.



## Syringe for Cleaning

An M-type joint is included on the tip of 10 mL syringes. This tool is useful when cleaning the interior of flow lines with solvent.



## Moisture Trap (Silica gel)

This absorbs moisture contained in gas supplies. If air from a compressor or other gas with high moisture levels is supplied, installing a filter regulator upstream from this moisture trap is recommended. Part of the silica gel will become discolored around the replacement period.

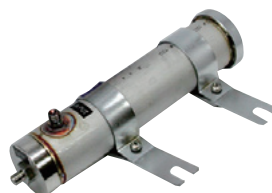

## Oxygen Trap

This trap can reduce the oxygen content in gas supplies to a 0.1 ppm level, with a capacity for absorbing about 2.5 L of oxygen. Reliability decreases if oxygen gets inside the ECD. Therefore, it is recommended that an oxygen trap be installed in the carrier and make-up gas lines. If a column prone to degradation by oxygen is used, it can also be helpful to install the trap in the carrier gas line.



## Filter for Flow Controller

This filter protects the flow controller (AFC) from contamination by samples discharged into an SPL split line or purge line. SPL-2030/SPL-U filters can be replaced by hand.

High visibility enables determining the filter contamination level at a glance.

Installing an additional filter is recommended if using aqueous solvents or discharging large quantities of sample from the split line.

#	Description	P/N	Remarks
(1)	Filter, Split Line	221-77580-42	Split line for Nexis GC-2030 and Brevis GC-2050 models
(2)	Filter, Split/Purge Line	221-42559-92	For adding a hydrocarbon filter to split or purge lines
(3)	Filter, Carrier Line	221-34121-94	For adding a moisture filter to the carrier line



(1) Filter, Split Line



(2) Filter, Split/Purge Line



(3) Filter, Carrier Line

# Operating Parts

## Gas Selector

Reconnecting flow lines to switch between gases requires shutting OFF the system. Even systems for manually switching between gases require purging lines thoroughly in the correct order to prevent the risk of different gases mixing inside gas cylinders.

The gas selector enables automatically and safely switching between the carrier gases being used.

In addition to enabling successive analyses using different carrier gases, the selector can also help reduce running costs by switching to an inexpensive carrier gas when no analysis is being performed.

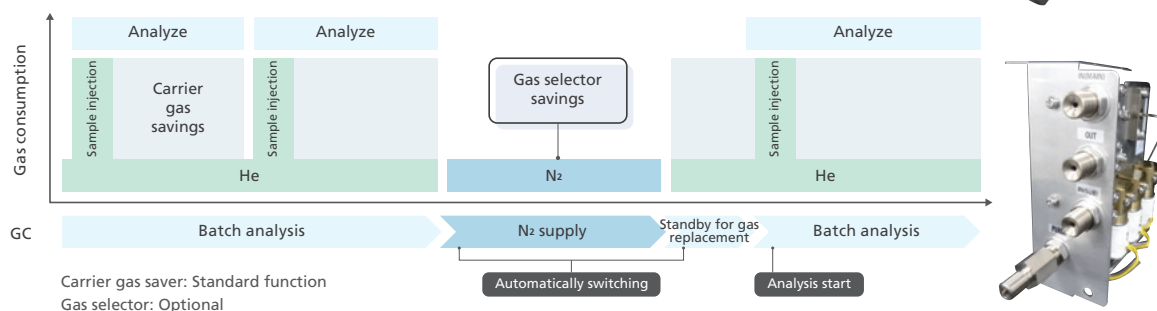
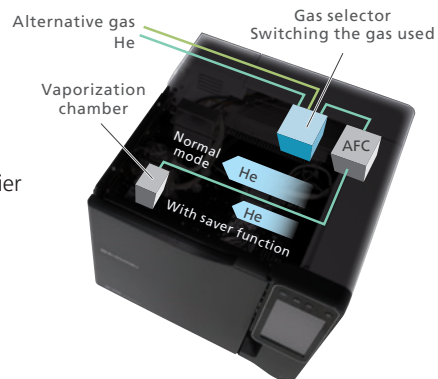

## Shimadzu M/G Type Joint

M and G-type tubing joints are used in Shimadzu chromatography systems.

Both types are connected by inserting a nipple into a socket welded (or soldered) to the ends of tubing and tightened by screwing a nut included with the nipple onto the male socket threads.

The M-type, fastened by crimping metal surfaces together (metal-to-metal contact), is mainly used for external gas chromatograph connections (such as for supplying gas to the flow controller). The G-type is tightened against a silicone or aluminum gasket in the joint. It is mainly used for internal gas chromatograph connections (such as to connect tubing or stainless steel columns to the sample injection unit).

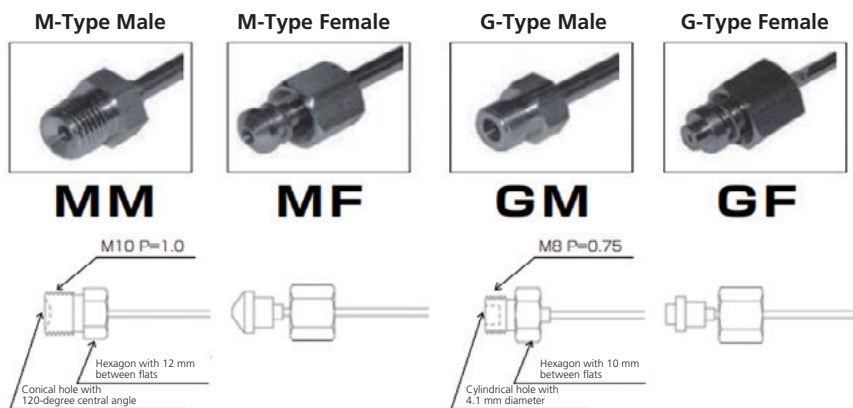

Description	P/N	Remarks
Pipe, MF-MM, 2m	221-26171-20	MF-MM tubing. Used to extend tubing length.
Pipe, MF-MM, 5m	201-48069-50	MF-MM tubing. Used to extend tubing longer distances. Requires using a socket for connections.
Socket	201-30219	MM-MM socket. Used to connect MF tubes.
Pipe, MM-LMF	221-73356-91	MM-MM tubing with left-hand threads. Used to convert from MF (right-hand threads) to left-hand threads.
Pipe, MF-MM-MF, 1m	221-72658-91	Pre-cleaned MF-MM-MF tubing. Used to connect tubing splits/branches.



## Pressure Regulator for High-Purity Gas PPR Series

For high-sensitivity analysis, in addition to the purity of gases used, contaminants originating from the pressure regulator can also cause problems. PPR series pressure regulators release extremely low contamination levels, making them ideal for high-sensitivity analysis. PPR series pressure regulators feature an air purge valve for purging any air trapped during cylinder replacement before supplying air.



(1) PPR-He

#	Description	P/N	Remarks
-	PPR-N <sub>2</sub>	221-35999-01	For nitrogen, air, or argon (blue) with right-handed threads on the cylinder side and gas tubing side
-	PPR-H <sub>2</sub>	221-35999-02	For hydrogen (red) with left-handed threads on the cylinder side and gas tubing side
(1)	PPR-He	221-35999-03	For helium (yellow) with left-handed threads on the cylinder side and right-handed threads on the gas tubing side
(2)	Inlet Gasket, PPR	221-35999-11	



(2) Inlet Gasket, PPR

## Gas Supply Tube

This stainless steel tube has a 3 mm outer diameter and 2 mm internal diameter. It is used to connect the pressure regulator and the flow controller on the gas chromatograph.

#	Description	P/N	Remarks
(1)	Gas Supply Tube, 2.5m	201-48067	Right-handed threads on pressure regulator side and GC side
-	Gas Supply Tube, 5m	201-48067-05	
-	Gas Supply Tube, 10m	201-48067-10	
-	Gas Supply Tube, 15m	201-48067-15	Left-handed threads on pressure regulator side and right-handed threads on GC side
-	Hydrogen Supply Tube for Carrier, 2.5m	221-18990-25	
-	Hydrogen Supply Tube for Carrier, 5m	221-18990-50	
-	Hydrogen Supply Tube for Carrier, 10m	221-18990-00	Left-handed threads on pressure regulator side and GC side
-	Hydrogen Supply Tube for Detector, 2.5m	221-73474-25	
-	Hydrogen Supply Tube for Detector, 5m	221-73474-50	
-	Hydrogen Supply Tube for Detector, 10m	221-73474-00	



(1) Gas Supply Tube, 2.5m

## Swagelok Adapter

This adapter is used to connect 1/8-inch O.D. stainless steel tubing to a Shimadzu M-type joint (also includes a Swagelok joint).

P/N	221-25975-92
-----	--------------

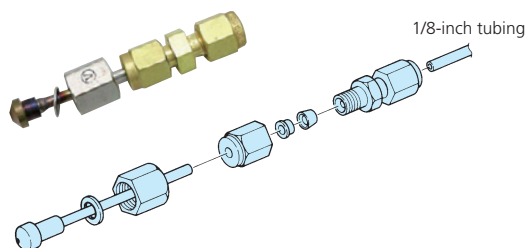

## Needle Valve

This valve is used to adjust the gas flowrate. The adjustment range for nitrogen gas with an inlet pressure of 300 kPa is 0 to 0.7 L/min. Shimadzu M-type joints are used on both inlet and outlet ends.

P/N	221-57298
-----	-----------



## FID Operation Parts Set

Description	P/N
Without a Pressure Regulator	221-38651-90
With a Pressure Regulator and Hydrogen Gas Tubing (right-handed threads)	221-38651-91
With a Pressure Regulator and Hydrogen Gas Tubing (left-handed threads)	221-38651-92

These are sets of parts for supplying hydrogen gas and auxiliary air to FID and FPD units. Because a compressor cannot be used for FTDs, parts other than for hydrogen gas cannot be used. For FTDs, use a PPR-H<sub>2</sub> pressure regulator with hydrogen gas tubing for the hydrogen gas and a PPR-N<sub>2</sub> pressure regulator and gas tubing (p. 25) for high-purity compressed air. If high-sensitivity analysis is required with an FID or FPD, it is recommended to use those items just like for an FTD.

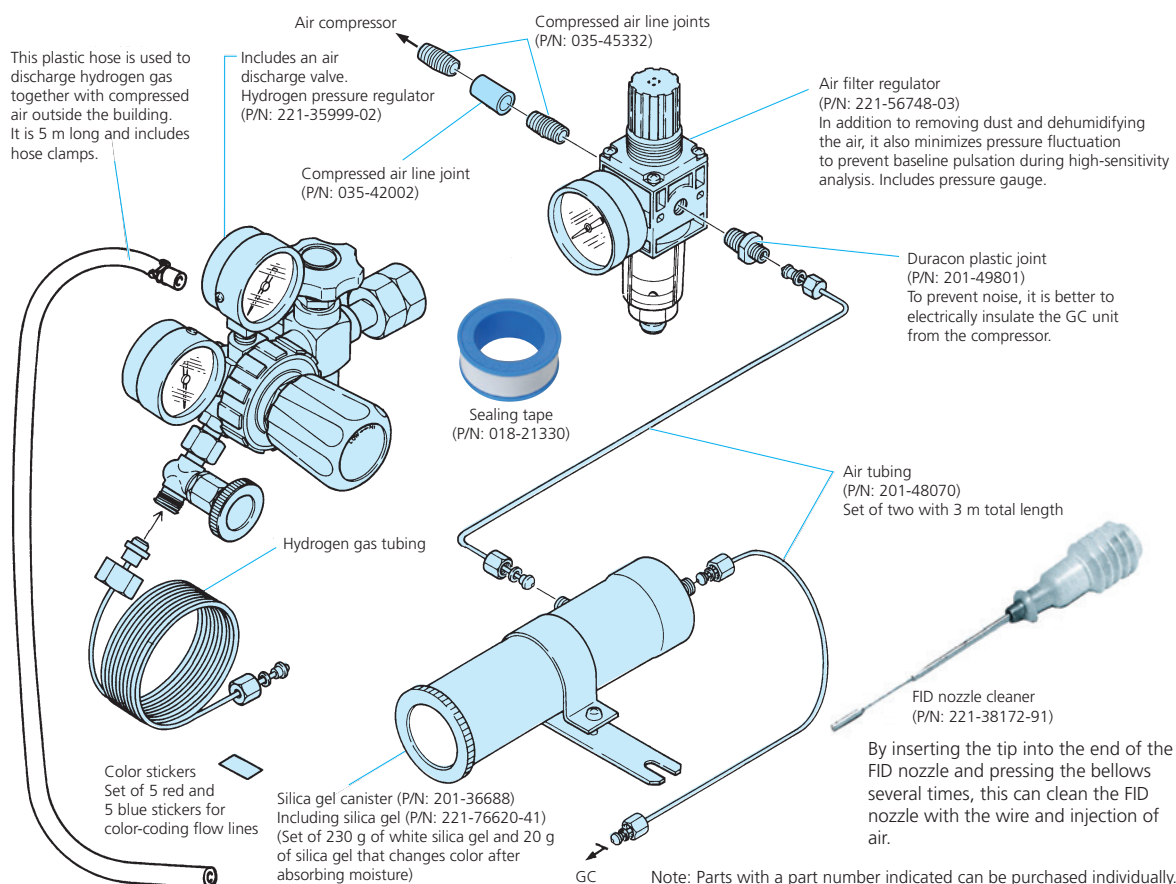

## Running Tool Kit, for GC

This set includes the device, the necessary tools, and standard accessories. There is a set that includes a pressure regulator (PPR series → P.25) for nitrogen (N<sub>2</sub>) and helium (He) used as carrier gas.

Description	P/N
Basic set (Right image)	221-38650-90
Basic set, PPR-N <sub>2</sub>	221-38650-91
Basic set, PPR-He	221-38650-92

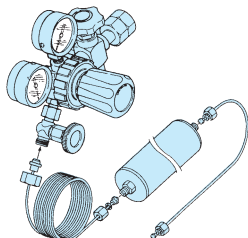

### Basic set contents

Gas pipes, gas filters, leak test liquid, various tools, inspection mirrors, micro syringes, column tags, quartz beads, color marks, table taps, organizing cases, etc.



## Data Processor

### Chromatography Data Acquisition Module CBM-201m

(P/N 221-80265-58)

The CBM-201m is a compact data acquisition module that is designed specifically for use with LabSolutions. It converts up to two analog chromatogram signals output from LC/GC systems into digital signals and sends them to LabSolutions. It supports connection to a computer via either a USB or Ethernet LAN connection.



## PC Peripherals

### RS-232C

Description	P/N	Remarks
RS-232C Cable, 2m	AK0198	9-pin to 9-pin crossover cable
RS-232C Cable, 4m	AK0198-010	9-pin to 9-pin crossover cable
RS-232C Cable, 10m	228-35397-90	9-pin to 9-pin crossover cable
2-port Expansion Port	088-50877-91	An RS-232C port can be added via a computer PCI bus.
4-port Expansion Port	088-50877-92	An RS-232C port can be added via a computer PCI bus.
USB-Serial Converter	AK0197	GC-2010 Plus or GC-2014 models can be connected by USB.
Serial Device Server	AK0560	GC-2010 Plus or GC-2014 models can be connected by Ethernet.

### Ethernet/USB

Description	P/N	Remarks
Switching Hub	088-54304-02	8 ports
LAN Cable, 2m	228-61083-41	Cat 5e compatible
LAN Cable, 5m	088-81104-86	Cat 5e compatible
LAN Cable, 10m	088-81104-87	Cat 5e compatible
USB Cable, 2m	088-50825-50	USB2.0



Shimadzu Corporation

[www.shimadzu.com/an/](http://www.shimadzu.com/an/)

**For Research Use Only. Not for use in diagnostic procedures.**

This publication may contain references to products that are not available in your country. Please contact us to check the availability of these products in your country.

Company names, products/service names and logos used in this publication are trademarks and trade names of Shimadzu Corporation, its subsidiaries or its affiliates, whether or not they are used with trademark symbol "TM" or "®".

Third-party trademarks and trade names may be used in this publication to refer to either the entities or their products/services, whether or not they are used with trademark symbol "TM" or "®".

Shimadzu disclaims any proprietary interest in trademarks and trade names other than its own.

The contents of this publication are provided to you "as is" without warranty of any kind, and are subject to change without notice. Shimadzu does not assume any responsibility or liability for any damage, whether direct or indirect, relating to the use of this publication.